



サンコウ膜厚計
SWT-8000/8100
取扱説明書

株式会社 **サンコウ電子研究所**

東京・大阪・名古屋・福岡・川崎

安全上のご注意	1
お守り下さい	3
準備	4
・ 同梱品	4
・ 各部の名称	5
・ 本器に電池を入れる	6
・ プローブの接続、取り外し	7
・ プローブの持ち方	8
・ プローブの押し当て方	8
操作方法	9
(1) 電源の入れ方	9
(2) 電源の切り方	9
(3) ゼロ調整	10
(4) ゼロ調整 —特殊な調整方法—	12
(5) 標準調整	15
(6) 検量線の消去	18
機能の切替	19
(1) 連続測定モードの切替	19
(2) 分解能の切替	21
(3) キーロックモードの切替	22
測定	23
データを送る (SWT-8100)	24
こんな時は (故障かな?と思ったら)	25
仕様 ◆本体	27
◆プローブ (オプション)	28
参考資料 (測定の原理)	29

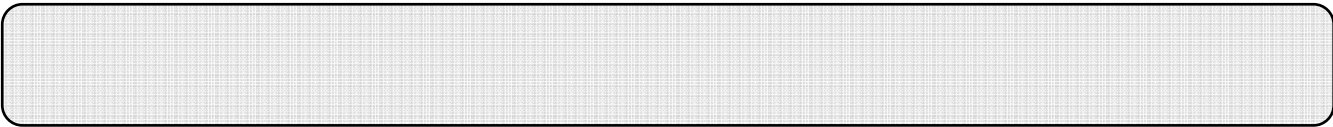

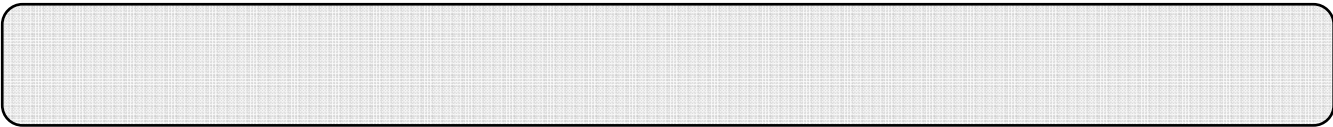

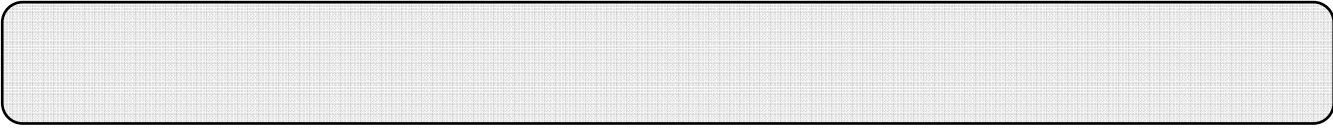
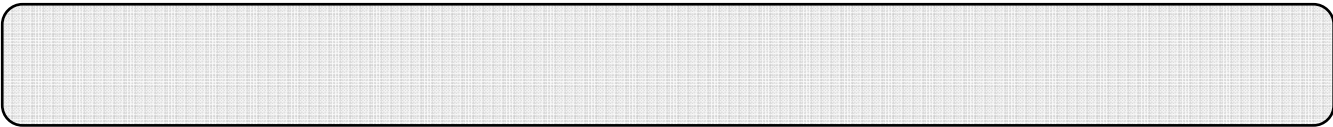

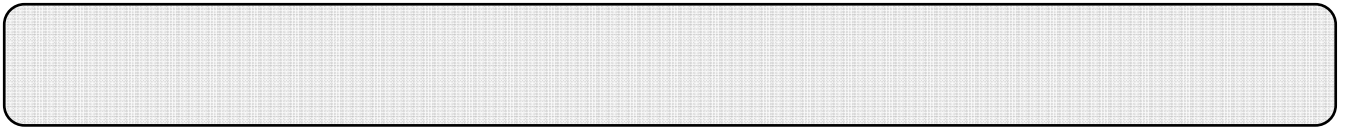

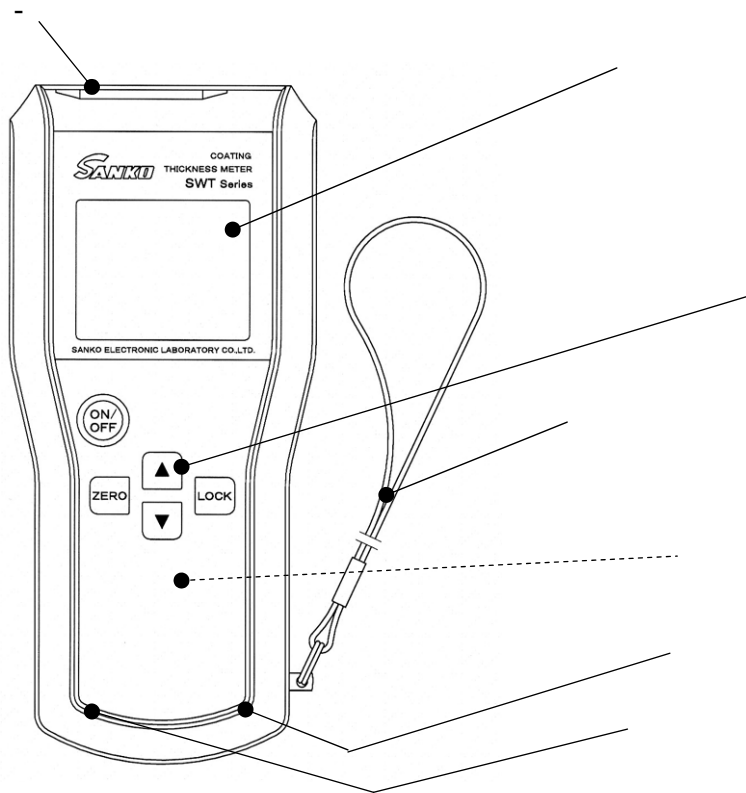

ZERO

LOCK

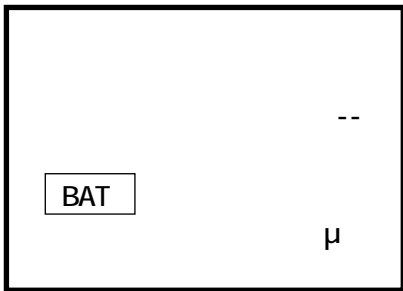
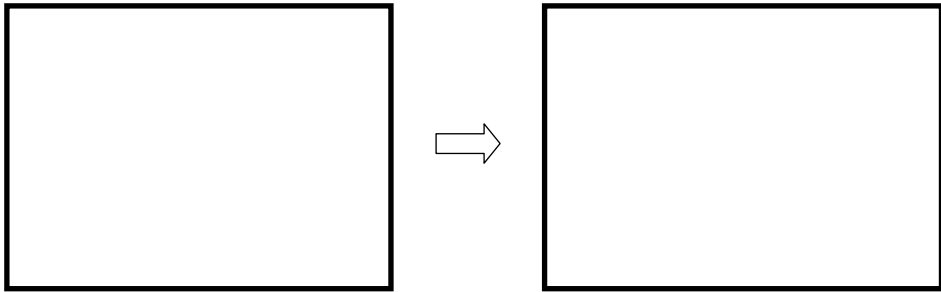
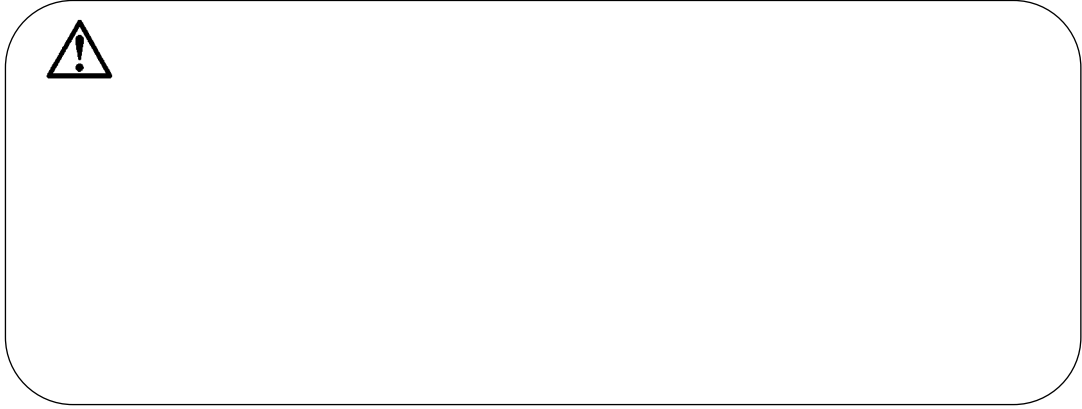

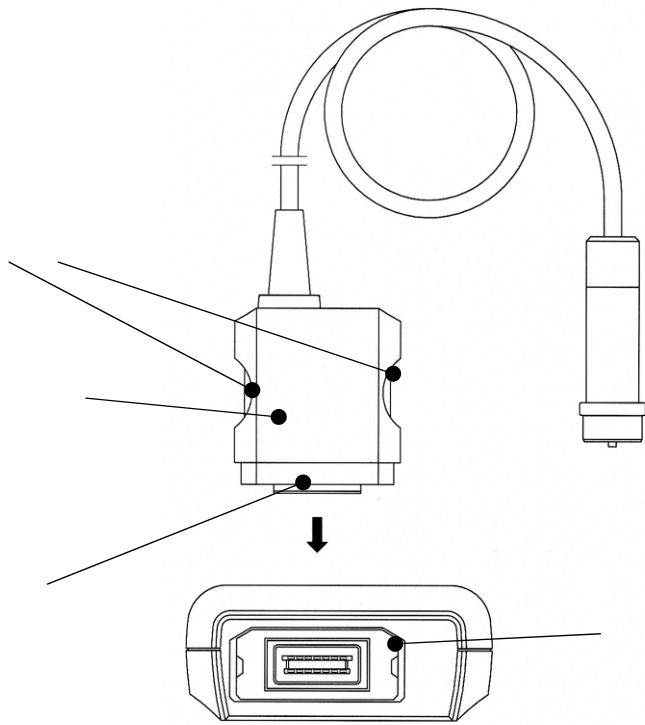

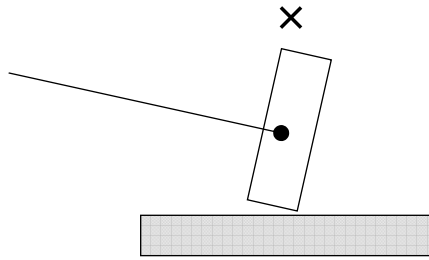
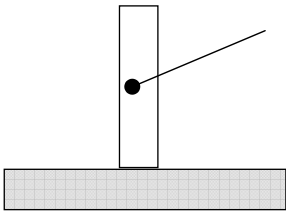
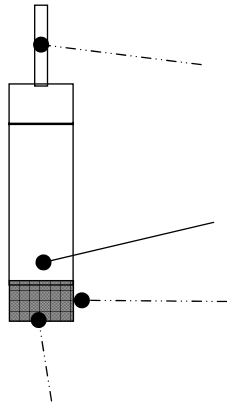

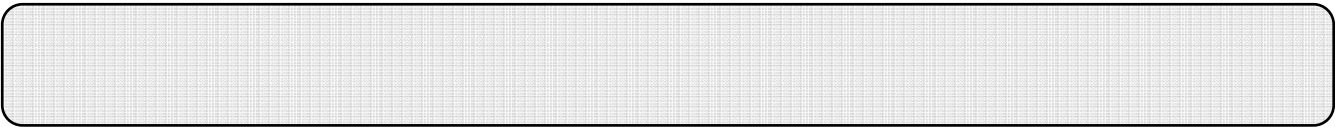

ON OFF

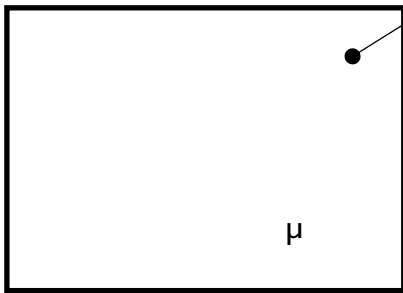
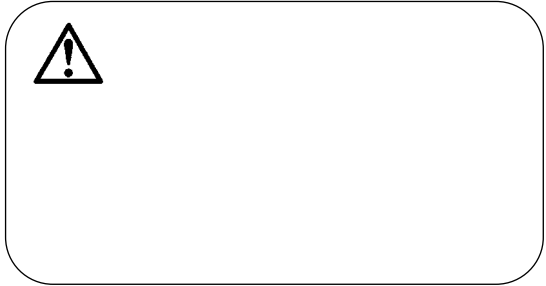

ON OFF

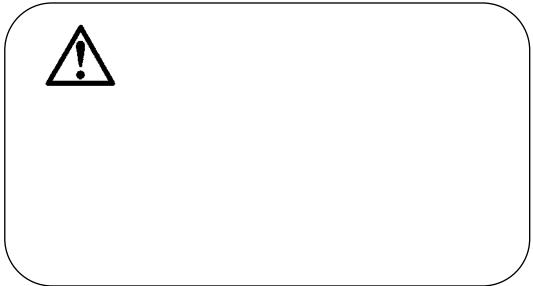

ZERO

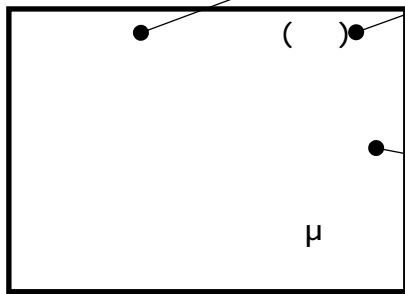
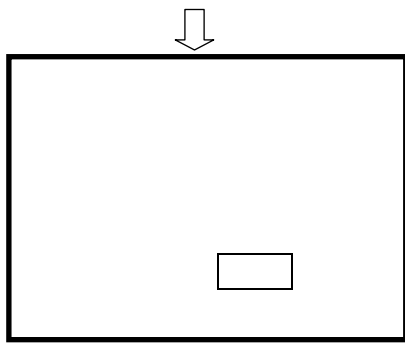

ZERO

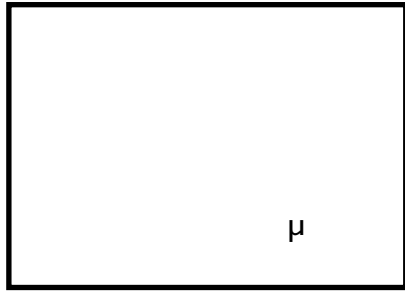

μ



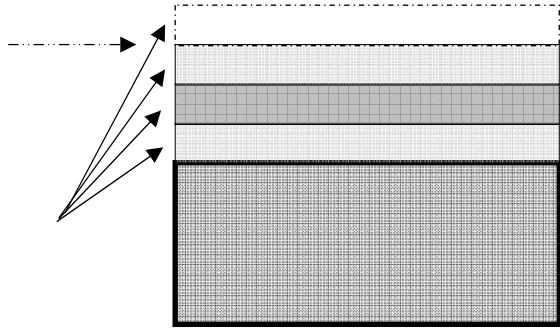

μ

-
- ZERO

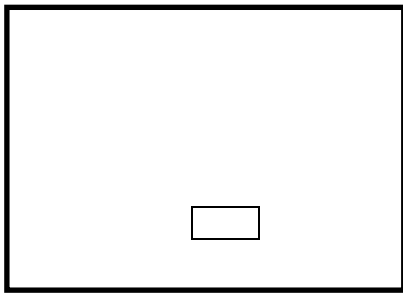

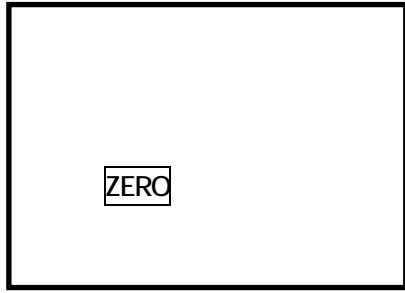

ZERO

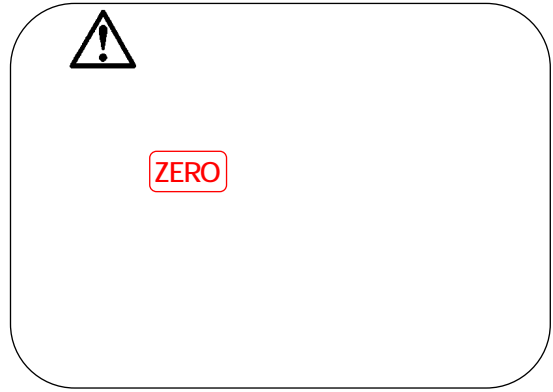

ZERO



ZERO

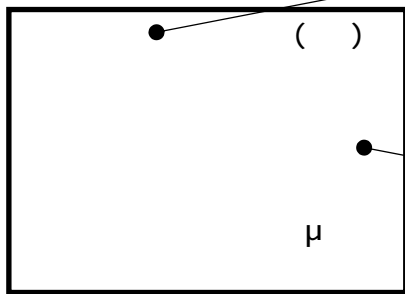
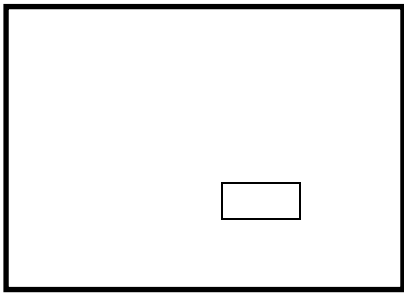

ZERO

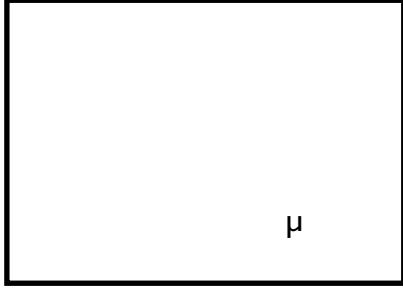

μ



-
-
-
-

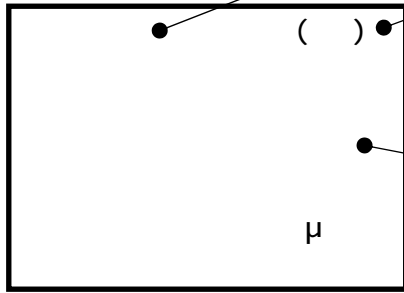

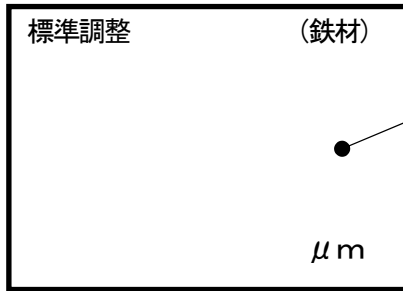
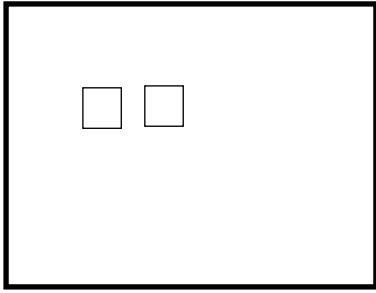

μ

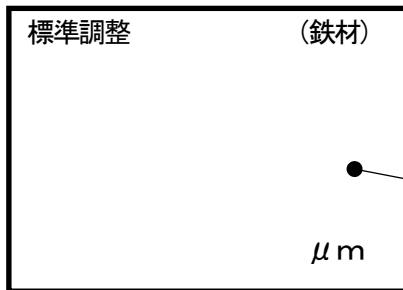



•

•

CAL

ZERO

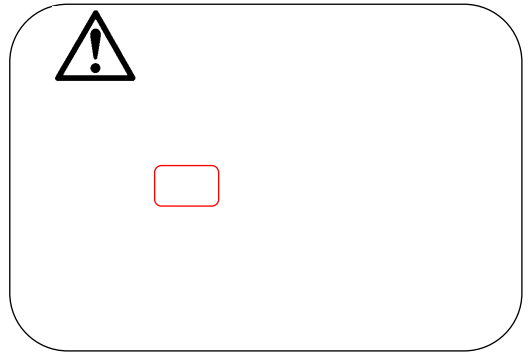
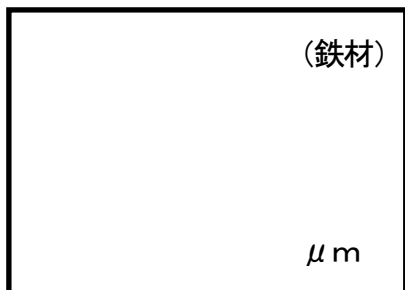

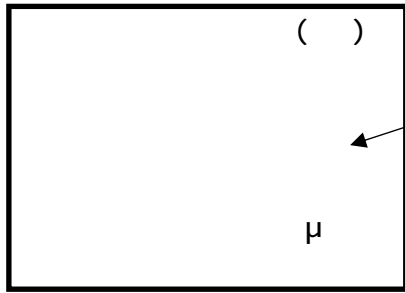
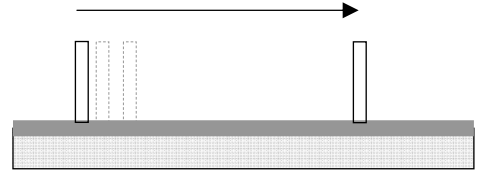
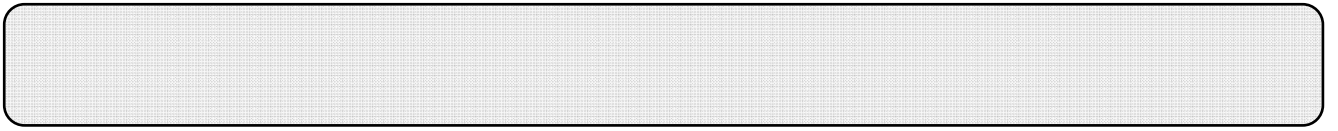

ZERO

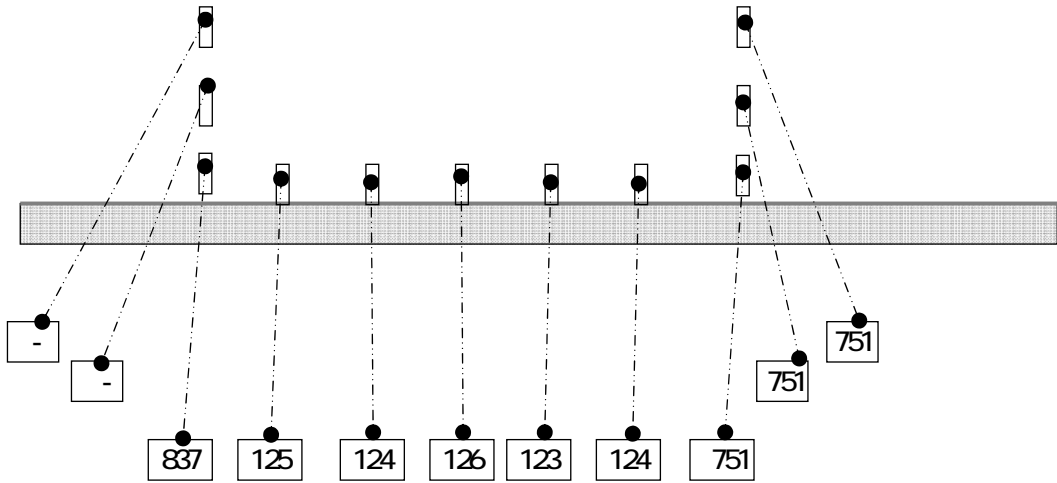

OFF

ON



ZERO

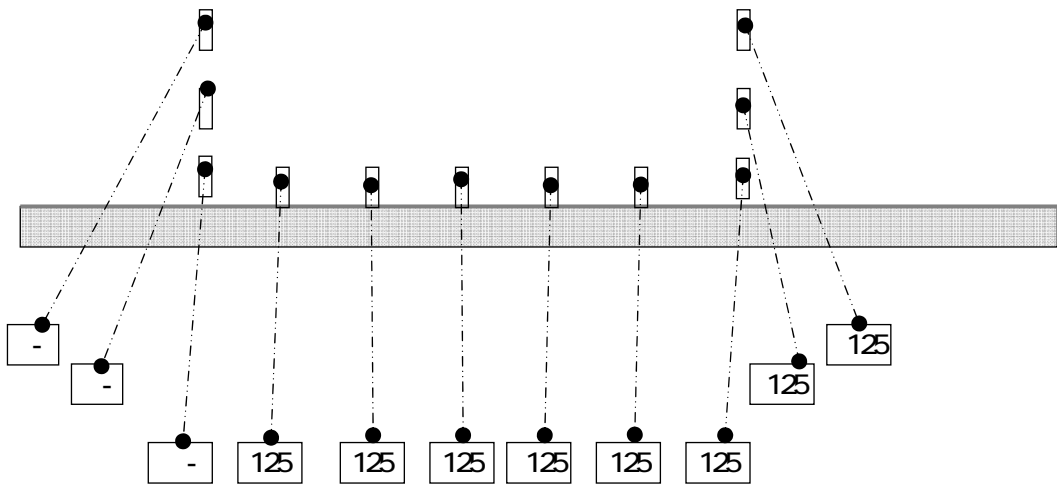

μ
μ

μ

μ

μ

LOCK

ON/OFF

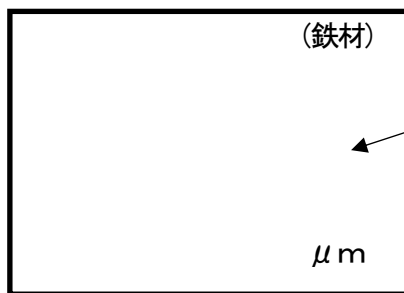

μ μ μ μ μ

μ

LOCK

ON/OFF

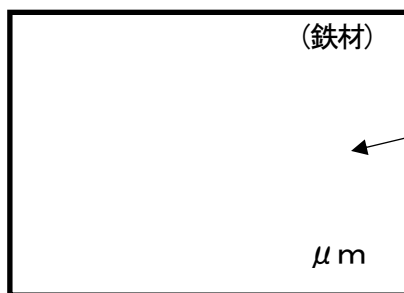

- ON LOCK

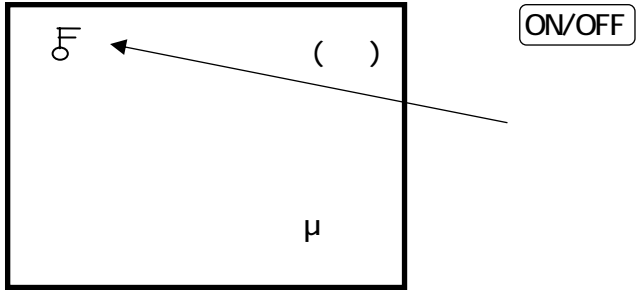

- ON/OFF

- ON/OFF

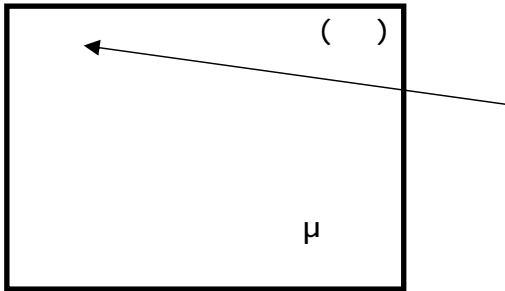

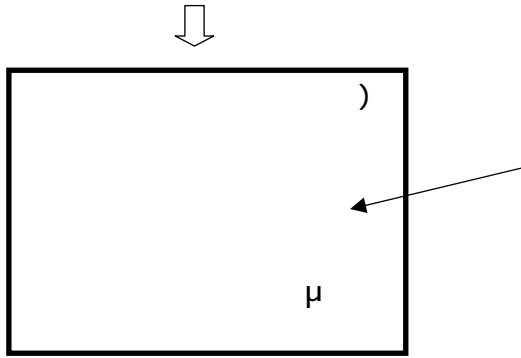
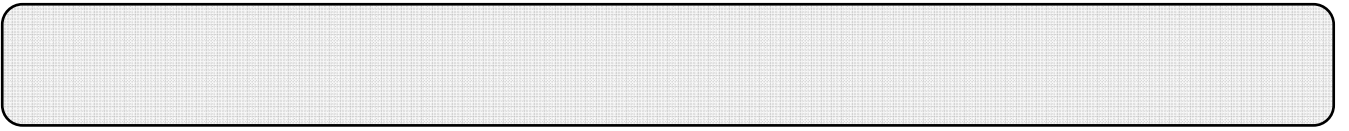



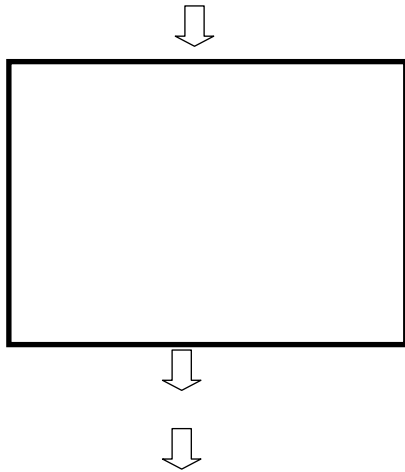

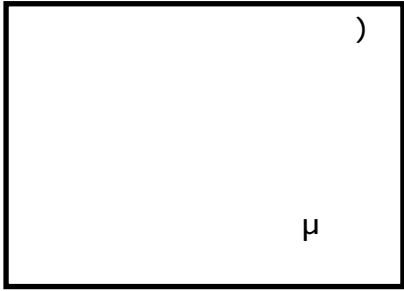
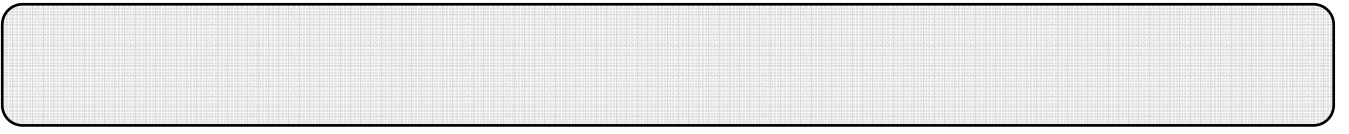

OFF

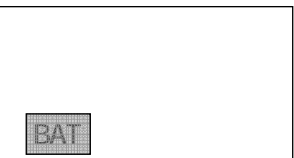





ON/OFF		
ON/OFF		
		
		
		
	ON/OFF	
	ON/OFF	ON/OFF

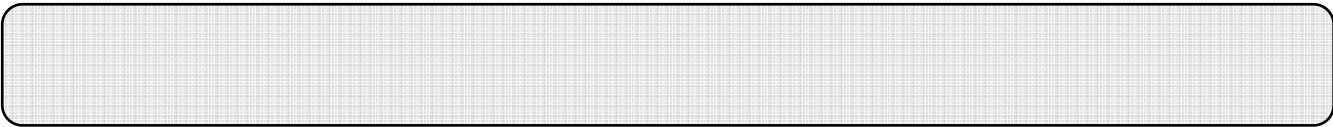

CAL	
	3
	<input type="button" value="ON/OFF"/> <input type="button" value="ZERO"/> <input type="button" value=""/> <input type="button" value=""/> <input type="button" value="LOCK"/>
	x
	AC USB USB
	x x mm

	Fe 2 5	0 6	2 0
	2 50	600μ	2 00
	1μ 0 999μ 0 1μ 0 400μ 0 5μ 400 500μ 0 01mm 1 00 2 50mm	1μ 0 600μ 0 1μ 0 400μ 0 5μ 400 500μ	1μ 0 999μ 0 1μ 0 400μ 0 5μ 400 500μ 0 01mm 1 00 2 00mm
	0 100μ ± μ ± 2 101μ 2 50 ± 2	0 100μ ± 1μ ± 2 101μ 600μ ± 2	0 100μ ± 1μ ± 2 101μ 2 00 ± 2
	x mm -----	x mm -----	x mm -----

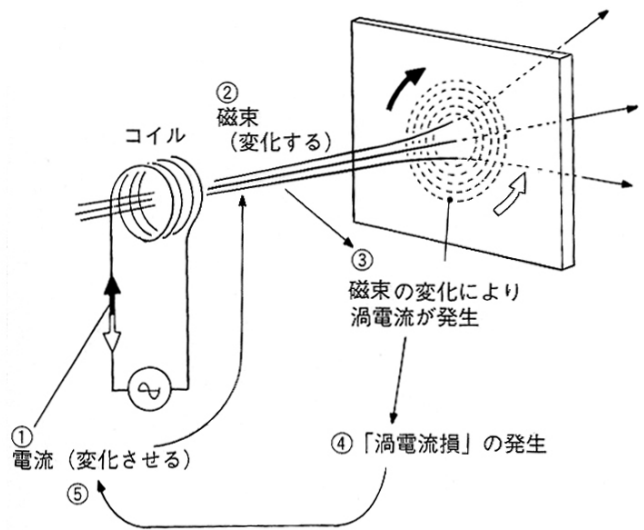
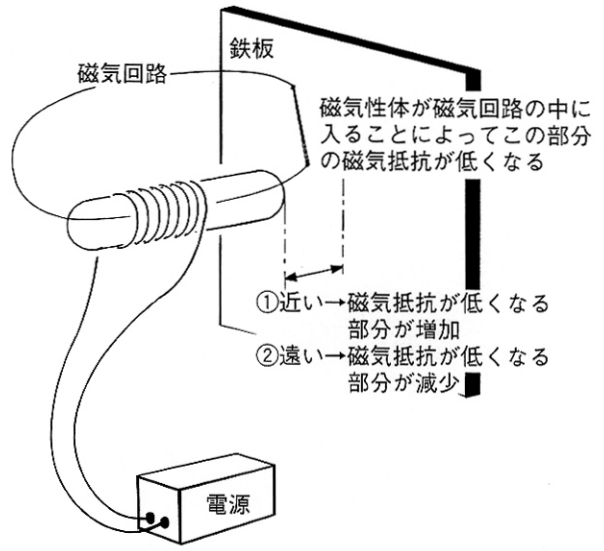
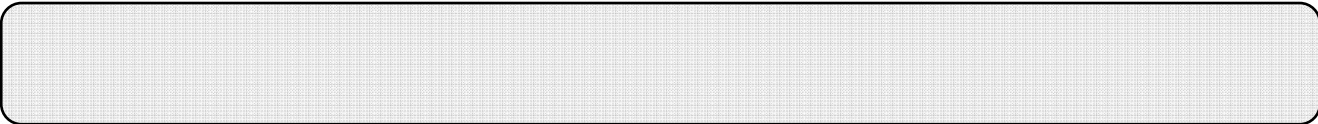

営業品目● 膜厚計、ピンホール探知器、
水分計、鉄筋探査機、結露計、
検針器、鉄片探知器、粘度計



株式会社 サンコウ電子研究所

東京営業所：〒101-0047 東京都千代田区内神田 2-6-4 柴田ビル2階
TEL 03-3254-5031 FAX 03-3254-5038

大阪営業所：〒530-0046 大阪市北区菅原町 2-3 小西ビル
TEL 06-6362-7805 FAX 06-6365-7381

名古屋営業所：〒462-0847 名古屋市北区金城 3-11-27 名北ビル
TEL 052-915-2650 FAX 052-915-7238

福岡営業所：〒812-0023 福岡市博多区奈良屋町 11-11
TEL 092-282-6801 FAX 092-282-6803

本社：〒213-0026 川崎市高津区久末 1677
TEL 044-751-7121 FAX 044-755-3212

URL <http://www.sanko-denshi.co.jp> E-mail info@sanko-denshi.co.jp